

Beck.

The factory-set pressure switches.



Pressure switch 901

with factory-set pressure setting

Application

Factory-set pressure switch monitoring overpressure, vacuum or differential pressure of liquid and gaseous – also aggressive – media.

Pressure setting and switching differential are factory-set by the manufacturer.

Temperature range

Ambient temperature from -20°C to 85°C .
Temperature of media up to 85°C or 130°C depending on material of pressure connection and diaphragm.

Diaphragm material

Depending on media NBR, Silicone, FKM (Viton®), EPDM.
For 901.30 Silicone, others upon request.

Electrical rating

Values indicated for resistive load

AgNi-contacts: 6 (1.5) A/250 VAC
2 A/24 VDC

Gold-plated contacts: 100 mA/24 VAC
30 mA/24 VDC

AgNi-contacts up to 10 A/250 VAC can be supplied upon request.

Electrical connection

AMP connection 6.3 mm x 0.8 mm DIN 46244.

Arrangement of contacts

for 901.1x, 901.30,
901.41, 901.51

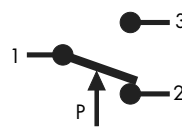

only for 901.2x

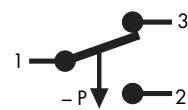

CE Conformity

each depending on technical specification: Low Voltage Directive 2006/95/EC; RoHS Directive 2011/65/EC; ATEX Directive 94/9/EC; Product types tested by TUV.

Life

Minimum 10^6 cycles.

Damping

Restrictors alternatively with 0.3/0.5/0.8 mm diameter.

Accessories

Various mounting brackets and protection caps with IP 44, IP 54 and IP 65.

Mounting position

Mounting in any position, to be specified for settings below 100 mbar.

Pressure connection

Type	Tube connection			Threaded connection			
	5.0 mm	6.5 mm	10.0 mm	M10 x1	G1/8	G1/4	G1/2
901.1x	PA	PA, PPS	PA, PPS	PA, PVDF CuZn40, V ₂ A	PA, PVDF CuZn40, V ₂ A	PVDF CuZn40, V ₂ A	CuZn40
901.2x	PA	PA, PPS	PA, PPS	PA, PVDF CuZn40, V ₂ A	PA, PVDF CuZn40, V ₂ A	CuZn40, V ₂ A	CuZn40
901.30		PA					
901.41		PA, PPS	PA, PPS	PA, PVDF CuZn40, V ₂ A	PA, PVDF CuZn40, V ₂ A	CuZn40, V ₂ A	CuZn40
901.51				CuZn40	CuZn40, V ₂ A	CuZn40, V ₂ A	

PA = polyamide, PVDF = polyvinylidene difluoride, PPS = polyphenylsulfide, CuZn40 = brass, V₂A = stainless steel

For temperature above 85°C metal or PPS pressure connection is required. Upon request pressure connections of other sizes, other plastics or brass nickel-plated are available.

Viton® is a registered trademark of DuPont Dow Elastomers.



Overpressure range

Type	Factory-set trip pressure		Standard switching differential		Tolerance band in % of trip pressure	Maximum positive working pressure standard/ extended	Maximum negative working pressure standard/ extended
	between	and	lower end of range	upper end of range			
901.1x	5 mbar	200 mbar	2.5 mbar	50 mbar	±10 %	0.5/4 bar	-/-1 bar
	200 mbar	1.000 mbar	50 mbar	150 mbar	±10 %	1/4 bar	-/-1 bar
901.41	500 mbar	3.000 mbar	200 mbar	600 mbar	±10 %	10 bar	-1 bar
901.51	1.0 bar	12 bar	0.2 bar	1.5 bar	±10 %	25 bar	-1 bar

Vacuum range

Type	Factory-set trip pressure		Standard switching differential		Tolerance band in % of trip pressure	Maximum positive working pressure standard/ extended	Maximum negative working pressure standard/ extended
	between	and	lower end of range	upper end of range			
901.2x	- 5 mbar	- 200 mbar	2.5 mbar	50 mbar	±10 %	0.5/4 bar	-1 bar
	- 200 mbar	- 900 mbar	50 mbar	150 mbar	±10 %	1/4 bar	-1 bar

Differential pressure range

Type	Factory-set trip pressure		Standard switching differential		Tolerance band in % of trip pressure	Maximum positive working pressure standard/ extended	Maximum negative working pressure standard/ extended
	between	and	lower end of range	upper end of range			
901.30	5 mbar	50 mbar	2.5 mbar	25 mbar	±10 %	100 mbar	-100 mbar

Pressure switch 901

with factory-set pressure setting

901.10/20

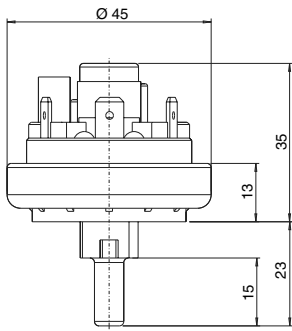

901.30

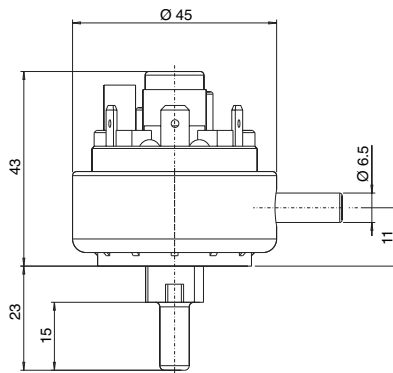

**Protection caps
6329 IP 44**

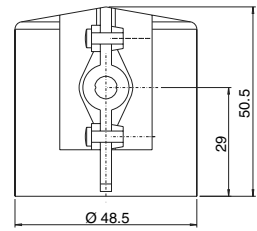

901.11/21/41

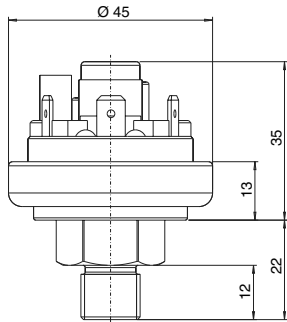

901.51

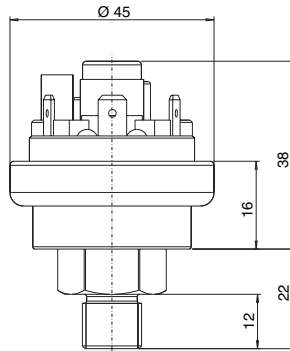

6345 IP 54

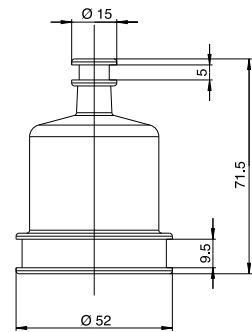

6371 IP 54 / 6372 IP 65

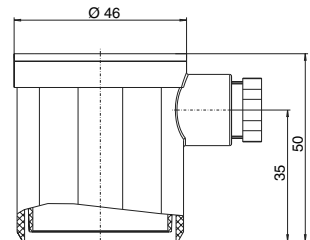

**Mounting brackets
6403**

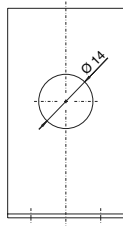
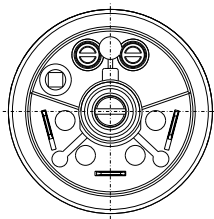

6404

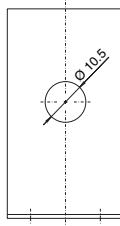

6405

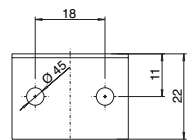
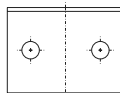
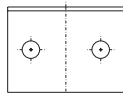
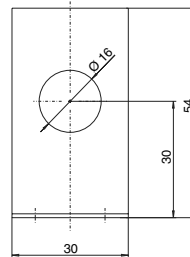

6374 IP 54 / 6375 IP 65

